



## **HARDWARE SECTIONS**

**BANCO ALUMINIUM LIMITED**

Phone : +91 265 2477200

E-mail : [sales@bancoaluminium.com](mailto:sales@bancoaluminium.com)

## TEE SECTIONS

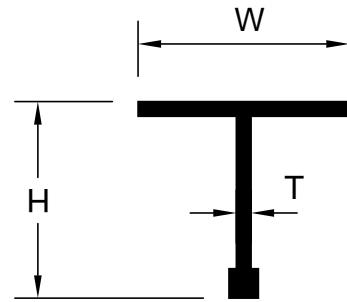
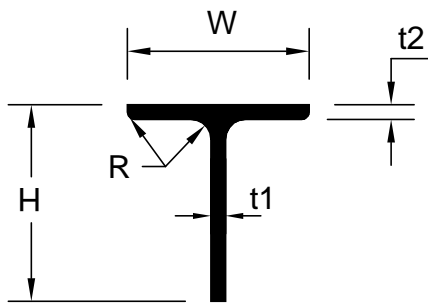

SR. NO.	SECTION NO.	H	W	t1	t2	R	WT KG/MTR.	SR. NO.	SECTION NO.	H	W	T	WT KG/MTR.
01	HAD 1001464	17.00	17.00	1.00	1.00		0.089	01	HAD 1001485/L	23.00	23.00	0.80	0.108
02	HAD 1001465	18.00	18.00	1.90	1.90		0.170	02	HAD 1001485/M	24.00	24.00	1.00	0.135
03	HAD 1034144	20.00	20.00	2.00	2.00		0.204	03	HAD 1001485/H	25.00	25.00	1.30	0.183
04	HAD 2034229	30.00	50.00	2.50	2.50		0.523	04	HAD 1001494/L	35.00	24.00	1.00	0.170
05	HAD 1001463	37.00	37.00	1.50	1.50		0.300	05	HAD 1001494/M	35.50	25.00	1.25	0.210
06	HAD 2007526	24.00	45.00	8.00	3.00		0.817	06	HAD 1001494/H	35.80	25.00	1.30	0.220
07	HAD 2007497	26.50	72.00	2.00	2.00	1.0	0.522	07	HAD 2000529	37.00	37.00	1.50	0.345
08	HAD 1007523	45.00	90.00	2.00	2.00		0.718	08	HAD 1000527	50.00	37.00	1.50	0.372
09	HAD 3007568	50.00	50.00	5.00	5.00		1.282						
10	HAD 2034169	50.00	80.00	5.00	5.00		1.686						
11	HAD 2007498	70.00	100.00	3.00	3.00		1.351						
12	HAD 2034094	100.00	45.00	8.00	8.00		2.987						
13	HAD 2034026	100.00	50.00	3.00	3.00		1.189						
14	HAD 3007496	135.0	75.00	20.0	12.0		9.073						

ALL DIMENSIONS ARE IN MM

WEIGHT TOLERANCES  $\pm 7$  TO 10%

REV.DT. 150519

BANCO ALUMINIUM LIMITED  
 Post Box No. 2563, Vadodara 390005, Gujarat, India  
 Phone : +91 265 2477200  
 E-mail : sales@bancoaluminium.com

## EQUAL CHANNELS

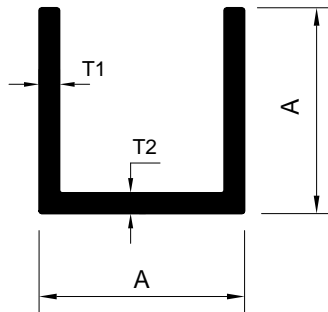

SR. NO.	SECTION NO.	A	T1	T2	WT KG/MTR.
01	HAD 1002254	9.00	1.00	1.00	0.077
02	HAD 1001338	9.50	0.90	0.90	0.065
03	HAD 1001340	9.50	1.25	1.25	0.087
04	HAD 1001343	12.00	1.10	1.10	0.100
05	HAD 1034065	12.50	1.50	1.50	0.138
06	HAD 1034096	15.00	1.50	1.50	0.169
07	HAD 1034047	15.00	2.00	2.00	0.220
08	HAD 2007454	20.00	2.00	2.00	0.409
09	HAD 2007473	22.00	2.00	2.00	0.334
10	HAD 2007477	25.00	2.00	2.00	0.383
11	HAD 2034043	25.00	3.00	3.00	0.558
12	HAD 1034017	30.00	2.00	2.00	0.463
13	HAD 2007449	30.00	3.00	3.00	0.680
14	HAD 2007457	40.00	3.00	3.00	0.923
15	HAD 2007515	40.00	4.00	4.00	1.208
16	HAD 2034022	50.00	3.00	3.00	1.165
17	HAD 3034117	50.00	4.00	4.00	1.532
18	HAD 3034051	50.00	5.00	5.00	1.889
19	HAD 2034097	60.00	4.00	4.00	1.856

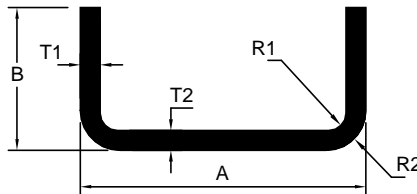

SR. NO.	SECTION NO.	A	B	T1	T2	R1	R2	WT KG/MTR.
01	HAD 1007480	8.70	25.00	2.00	2.00			0.294
02	HAD 1034209	9.00	15.00	1.20	1.20			0.117
03	HAD 1034136	15.00	20.00	2.00	2.00			0.274
04	HAD 1034057	16.00	19.00	1.20	1.20			0.167
05	HAD 1034018	18.00	30.00	2.00	2.00			0.398
06	HAD 1034128	20.00	15.00	2.00	2.00			0.247
07	HAD 2007459	20.00	30.00	2.00	2.00			0.409
08	HAD 2034095	22.00	8.00	2.50	2.50			0.221
09	HAD 1034016	22.00	30.00	2.00	2.00			0.420
10	HAD 2034103	25.00	20.00	2.00	2.00			0.328
11	HAD 1034106	25.00	50.00	2.75	2.75			0.886
12	HAD 1034165	30.00	20.00	2.00	2.00			0.355
13	HAD 1007556	40.00	20.00	2.00	2.00			0.409
14	HAD 2007428	40.00	20.00	3.00	3.00			0.599
15	HAD 2007576	40.00	30.00	3.00	3.00			0.760
16	HAD 3034113	40.00	49.00	9.40	10.0			3.058
17	HAD 1034170	50.00	25.00	1.80	1.80			0.467
18	HAD 2007436	50.00	25.00	2.00	2.00			0.518
19	HAD 2034116	50.00	25.00	2.50	2.50			0.640
20	HAD 2008542	50.00	25.00	3.00	3.00			0.761
21	HAD 1034164	50.00	30.00	2.00	2.00			0.571
22	HAD 1034072	50.00	30.00	3.00	3.00			0.841
23	HAD 2007444	50.00	40.00	4.00	4.00			1.317
24	HAD 2034182	50.00	40.00	5.00	5.00			1.619
25	HAD 3007482	50.80	25.40	3.17	3.17			0.814
26	HAD 2034118	53.50	30.00	3.00	3.00			0.869
27	HAD 1007469	54.50	50.00	2.00	2.00			0.812
28	HAD 1007474	58.90	35.50	1.20	1.20	1.00		0.413
29	HAD 2007450	60.00	30.00	4.00	4.00			1.209
30	HAD 3034059	60.00	40.00	3.00	3.00			1.084
31	HAD 3007486	60.00	40.00	4.00	4.00			1.424
32	HAD 3034073	60.00	40.00	5.00	5.00			1.754
33	HAD 1034074	60.00	50.00	2.00	2.00			0.841
34	HAD 1007544	64.80	8.50	1.40	1.40			0.298
35	HAD 2001372	75.00	40.00	5.00	5.00	0.50	0.50	1.960
36	HAD 2001377	76.20	38.10	6.35	6.35	1.00	1.00	2.394
37	HAD 2007452	76.20	43.78	6.50	3.98	5.99	5.99	2.215
38	HAD 2007453	80.00	40.00	4.00	4.00			1.641
39	HAD 2007429	80.00	50.00	5.00	5.00			2.295
40	HAD 2034171	100.00	25.00	2.00	2.00			0.787
41	HAD 2007465	100.00	50.00	5.00	5.00			2.564
42	HAD 2007468	100.00	64.00	6.40	6.40			3.718
43	HAD 2001368	100.00	65.00	15.00	11.00	7.00		7.110
44	HAD 3034162	101.60	41.83	6.68	6.68			3.098
45	HAD 3007485	101.60	50.80	6.35	6.35			3.265
46	HAD 2001356	101.60	50.80	7.94	6.35	9.14		3.730
47	HAD 2034185	106.00	40.00	3.00	3.00			1.457
48	HAD 2007445	109.60	44.70	12.70	10.00	5.00	1.00	5.364
49	HAD 3034228	127.00	48.00	8.00	8.00	9.50		4.574
50	HAD 3034066	140.00	60.00	7.00	7.00			4.648
51	HAD 3007478	140.00	70.00	8.00	8.00			5.701
52	HAD 3007479	160.00	80.00	10.00	10.00			8.099
53	HAD 3034069	170.00	85.00	10.00	10.00			8.640

ALL DIMENSIONS ARE IN MM

WEIGHT TOLERANCES ±7 TO 10%

REV.DT. 150519

BANCO ALUMINIUM LIMITED  
 Post Box No. 2563, Vadodara 390005, Gujarat, India  
 Phone : +91 265 2477200  
 E-mail : sales@bancoaluminium.com

HAD 2000761  
(KG/MTR = 0.228)

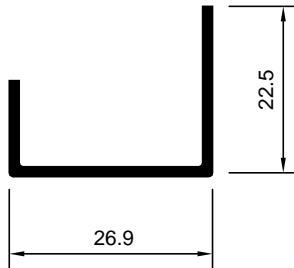

HAD 2000762  
(KG/MTR = 0.202)

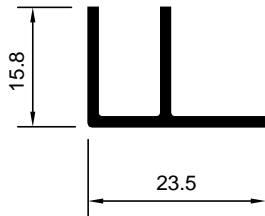

HAD 1000763  
(KG/MTR = 0.254)



HAD 1000781  
(KG/MTR = 0.080)

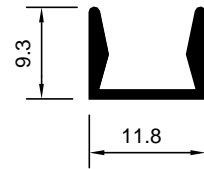

HAD 2005554  
(KG/MTR = 1.140)

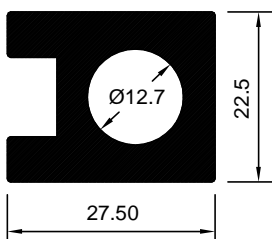

HAD 2005555  
(KG/MTR = 1.224)

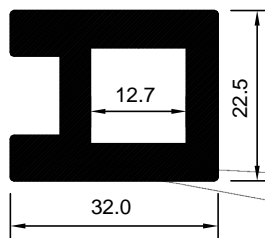

HAD 2005712  
(KG/MTR = 0.689)

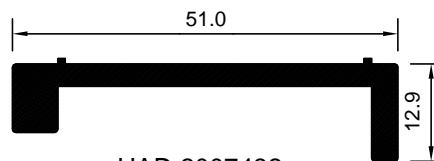

HAD 2003523  
(KG/MTR = 0.331)

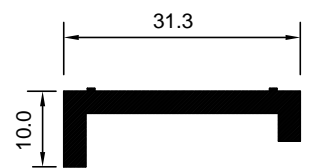

HAD 2007432  
(KG/MTR = 0.704)

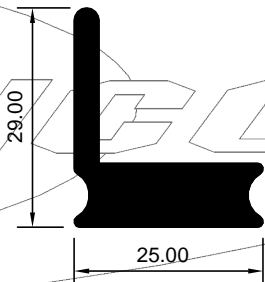

HAD 2007427  
(KG/MTR = 0.485)

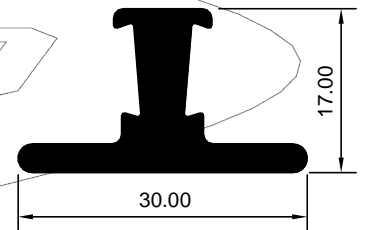

HAD 2005802  
(KG/MTR = 2.710)

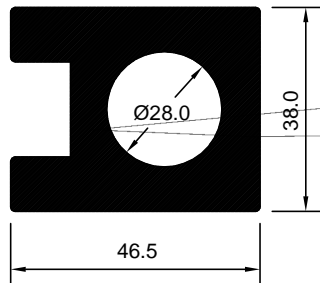

HAD 2005801  
(KG/MTR = 3.133)

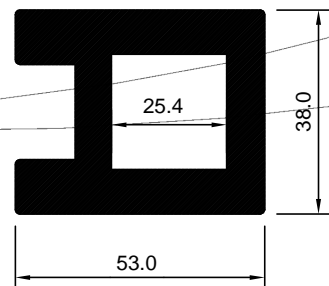

HAD 2007526  
(KG/MTR = 0.817)

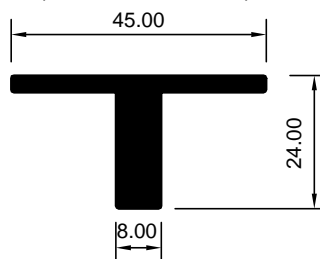

HAD 1005587  
(KG/MTR = 0.390)

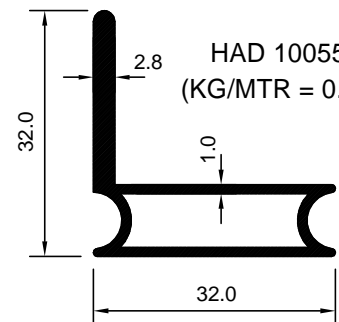

HAD 3007542  
(KG/MTR = 5.712)

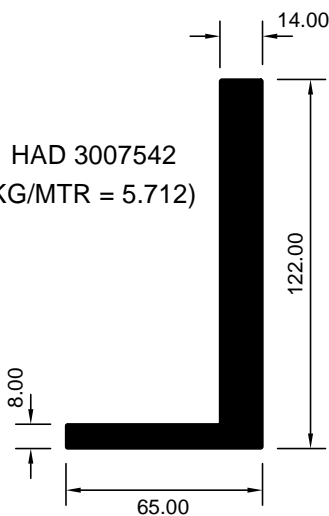

HAD 1007451  
(KG/MTR = 0.175)

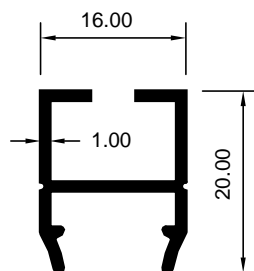

HAD 3007500  
(KG/MTR = 2.467)

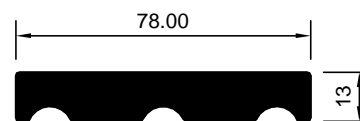

HAD 1007462  
(KG/MTR = 0.290)

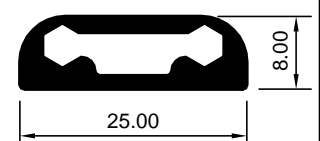

ALL DIMENSIONS ARE IN MM

WEIGHT TOLERANCES  $\pm 7$  TO 10%

REV.DT. 040119

BANCO ALUMINIUM LIMITED  
Post Box No. 2563, Vadodara 390005, Gujarat, India  
Phone : +91 265 2477200  
E-mail : sales@bancoaluminium.com















